

# A GUIDE TO FIRE ALARM BASICS

A fire alarm system is a crucial part of the overall fire protection and life safety strategy of a building. A fire alarm system serves many functions and the differences between the functions can be a bit confusing, so this visual guide to fire alarm basics was created. The objective of this document is to discuss some of the major components and functions of a fire alarm system.

## FIRE ALARM SYSTEMS | DIAGRAM

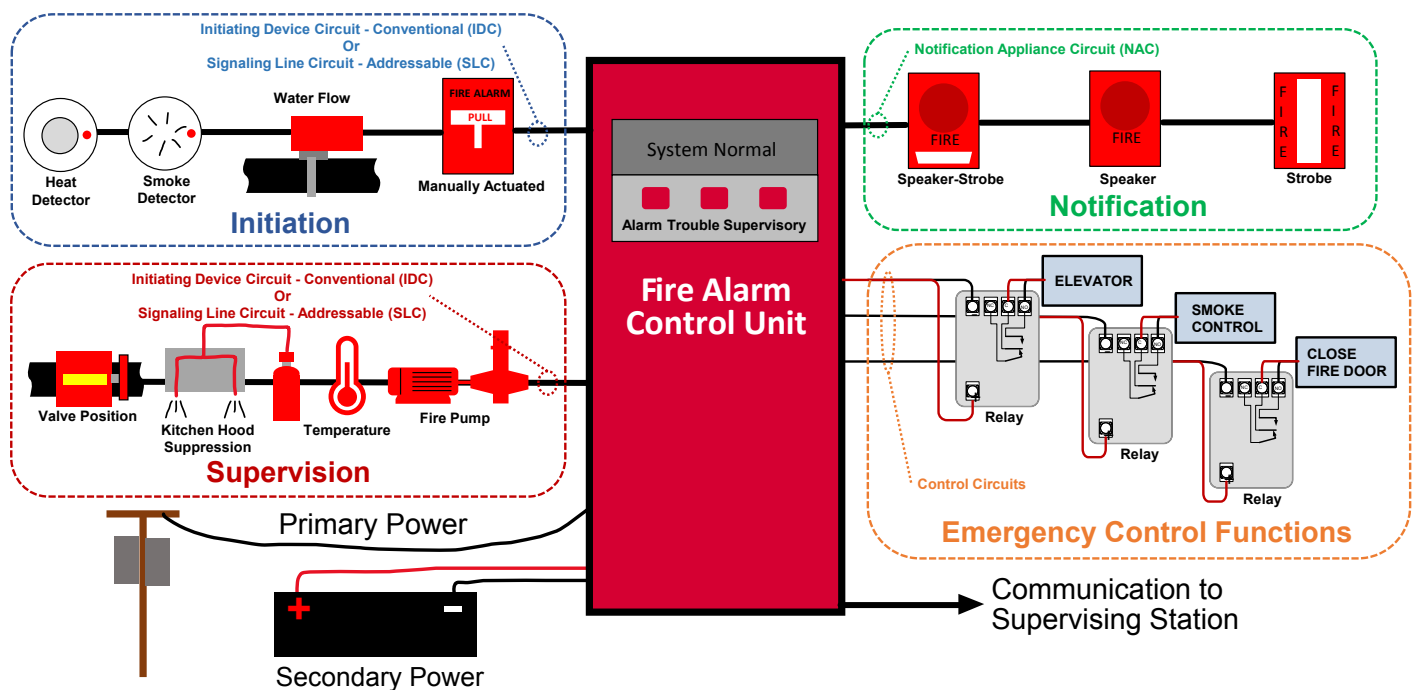

### FACU - Fire Alarm Control Unit

The fire alarm control unit serves as the brain of the fire alarm system by monitoring all the inputs and controlling all the outputs. Some may also refer to this as a fire alarm control panel or fire alarm panel. The different types of conditions that can be seen at the fire alarm control unit are alarm, supervisory, and trouble, these conditions can also result in a signal being sent to the supervising station.

#### Alarm

An alarm condition means there is an immediate threat to life, property, or mission. An example of this would be a smoke detector sending a signal to the fire alarm control unit that there is a presence of smoke, which would initiate notification to the occupants to evacuate.

#### Trouble

A trouble condition means there is an issue or fault with the fire alarm system. An example would be a break in an initiating device circuit. This would show up as a trouble signal on the control unit.

#### Supervisory

A supervisory condition means there is an issue with a system, process, or equipment that is monitored by the fire alarm control unit (see Part 2 on Supervision). An example of this would be a sprinkler system valve being closed, this would show up as a supervisory signal on the control unit.

- Part 1 | **Initiation**
- Part 2 | **Supervision**
- Part 3 | **Power Supply**
- Part 4 | **Notification**
- Part 5 | **Emergency Control Functions**
- Part 6 | **Off-Premises Signaling and Supervising Stations**

**PART 1 | Initiation**

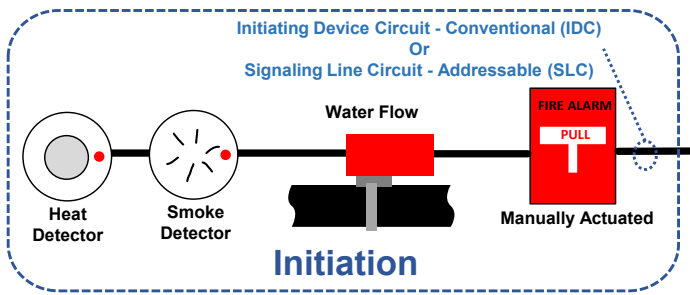

The main function of the initiation portion of a fire alarm system is to report the status of a protected space or the existence of a fire. The components include all devices and circuits that send a signal to a fire alarm control unit (FACU) such as heat detectors, smoke detectors, carbon monoxide detectors, water flow switches, manually actuated devices, and pressure switches. Depending on the system, the signal from an initiating device can create an alarm condition or a supervisory condition. Based on the type of detectors and FACU, the signals can be sent over an initiating device circuit (IDC) for conventional systems, or a signaling line circuit (SLC) for addressable systems.

Conventional initiating devices are typically detectors that use a switch contact to short both sides of the initiating device circuit together. By doing so, the initiating device causes an increase in current flowing through the circuit, which the FACU interprets as an alarm signal. Once one device shorts the circuit, no other device on that circuit or "zone" can send a signal. Because of this, any device on the circuit or zone will put the entire zone into an alarm state. Zones are typically designed to enable someone to easily identify an area where the alarm is located, for example, in a school you may have a gymnasium zone circuit and an auditorium zone circuit that each contain multiple devices.

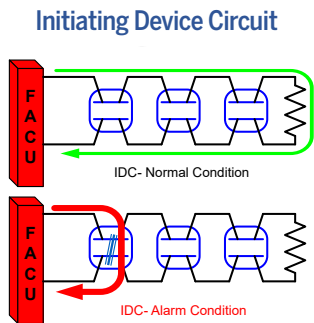

Addressable devices are either initiating devices or control/notification appliances that are capable of communicating a unique identification number or address to a control unit via a signaling line circuit. This identification consists of a binary string of 1s and 0s that indicate the address or location of that device on the circuit. When the FACU polls an initiating device, the initiating device responds with its status (normal, alarm, etc.) and address. The device address allows for the location of the detector to be identified at the FACU. When one initiating device is activated on a signaling line circuit, the FACU is still able to poll the other devices unlike a conventional initiating device circuit.

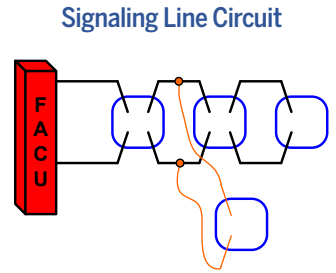

Additionally, some addressable initiating devices are able to also transmit to the FACU a range of values of smoke density, temperature variation, water level, water pressure changes, and other variables. And then the control unit software determines the set points for initiation of an alarm, supervisory, or trouble signal. These types of initiating device circuits are known as analog addressable as they are able to tell the FACU their address and their value.

Ionization smoke detectors utilize a small amount of radioactive material to ionize air molecules into positively and negatively charged molecules that create a small electric current. The introduction of smoke into that ionized air will reduce the amount of current and cause an alarm signal.

**Ionization Smoke Detector**

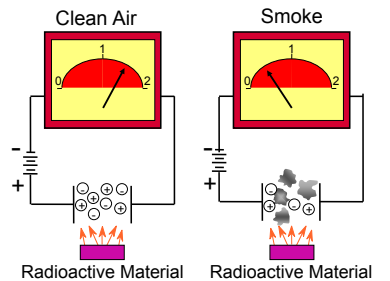

Photoelectric smoke detectors utilize a light source and a photosensitive cell. When smoke enters the chamber, light scatters and is picked up by the photosensitive cell, causing an alarm signal.

**Photoelectric Smoke Detector**

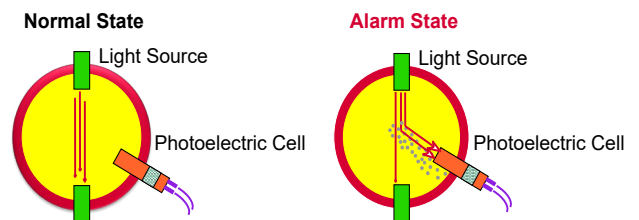

A beam smoke detector is like a photoelectric detector, except it is designed to cover a large area. A transmitter and receiver or reflector are placed to create a light beam across a space, when the amount of light being received by the receiver or reflected to the transmitter falls below a certain percentage, an alarm signal is sent.

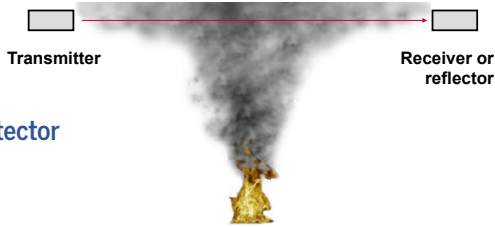

**Beam Smoke Detector**

A non-restorable fixed temperature heat detector utilizes solder that holds up a plunger. The solder melts at a specific temperature and causes the plunger to drop, which shorts the contacts and causes an alarm signal.

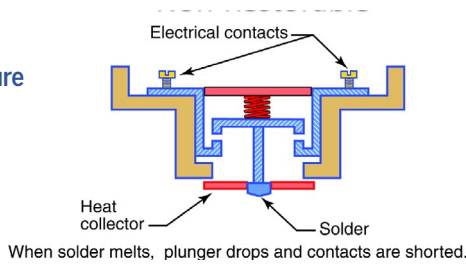

**Fixed Temperature Heat Detector Non-Restorable**

A restorable fixed temperature heat detector utilizes two metals that have different thermal expansion coefficients. At a specific temperature, these metals will bend and cause the plunger to short the contacts, which causes an alarm condition. When the metal cools it will bend back in the other direction and restore itself.

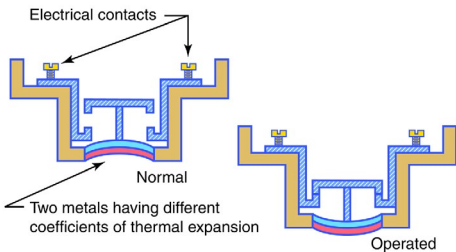

**Fixed Temperature Heat Detector Restorable**

A rate-of-rise detector utilizes an air chamber and a diaphragm. When a fire causes the air in the chamber to expand faster than it can escape out the vent, the increased pressure forces the diaphragm to close the contacts and initiate an alarm signal. This rate-of-rise detector also contains a fixed temperature plunger that will operate if the temperature exceeds the determined temperature.

**Rate-of-Rise Heat Detector**

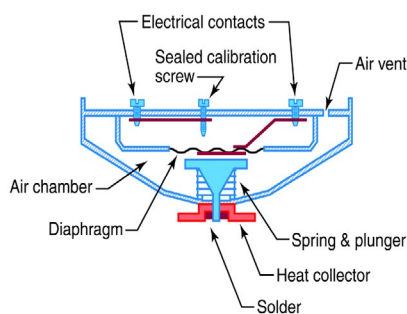

An analog addressable heat detector utilizes a thermistor element to constantly monitor the temperature. The response criteria, which can be a temperature above a specified level, or a specific rate of rise in the temperature, is programmed at the FACU.

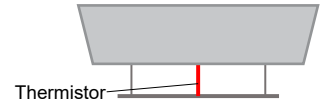

**Analog Addressable Heat Detector**

There are many different types of carbon monoxide (CO) detectors. One example of a CO detector is a Colorimetric detector. Like a photoelectric smoke detector, this detector contains a light source and a photocell that are constantly measuring for light being reflected from a chemical detector. In the presence of carbon monoxide, the chemical detector will change to a black color and light will no longer be reflected to the photocell, which will result in an alarm signal.

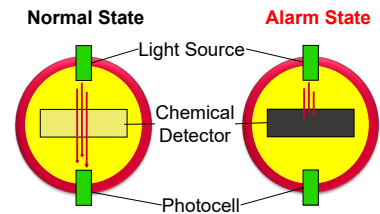

**Carbon Monoxide Detector**

Sometimes called manual fire boxes, pull stations, or call points, manually actuated initiating devices initiate an alarm signal when there is an input from a person, such as pulling a lever or pushing a button. These can require multiple actions to initiate such as lifting a cover or breaking glass prior to actuating the device.

**Manually Actuated Initiating Device**

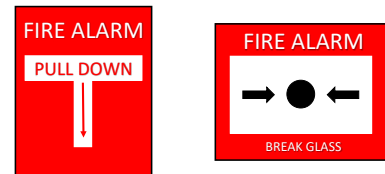

Flow switches are installed inside the piping of a sprinkler system and have a vane that moves with the flow of water. When water begins to flow within the pipe, the vane operates a switch that initiates an alarm.

**Vane Waterflow Switch**

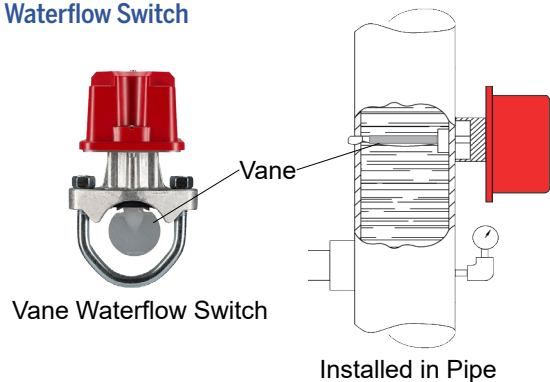

Pressure switches are installed on sprinkler systems to monitor for a change in water pressure. A signal will be sent to the FACU when there is an increase in water pressure, which means that water is flowing through the sprinkler alarm valve.

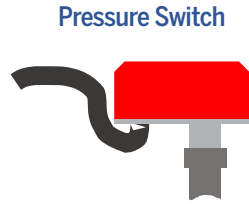

## PART 2 Supervision

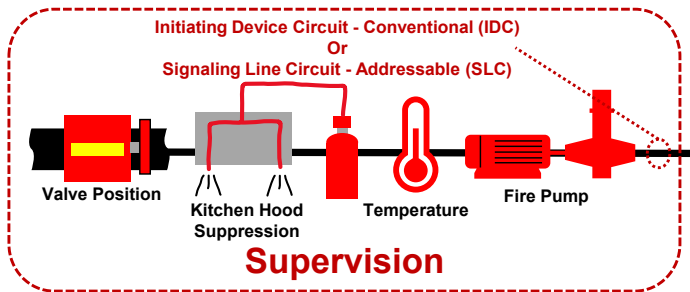

It is common and often required to utilize a fire alarm system to monitor the condition of other systems, processes, or equipment that are related to the building's fire and life safety or other systems that the owner would like to monitor. Supervision can include but is not limited to valves on fire protection systems, other fire protection systems such as kitchen hood suppression systems, valve room or storage tank temperatures, and fire pump condition. Issues with these systems would provide a signal to the fire alarm control unit via an initiating device circuit (IDC) for conventional systems, or a signaling line circuit (SLC) for addressable systems and would create a supervisory condition at the fire alarm control unit (FACU).

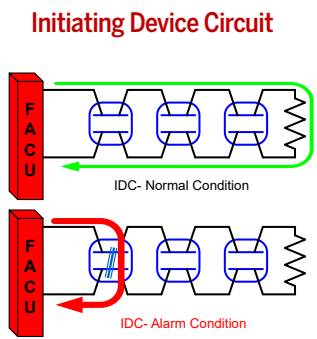

Conventional supervisory devices are devices that are used on an initiating device circuit and use a switch contact to short both sides of the device circuit together. By doing so, the device causes an increase in current flowing through the circuit, which the FACU interprets as a supervisory signal. Once one device shorts the circuit, no other device on that circuit or "zone" can send a signal. Because of this, any device on the circuit or zone will put the entire zone into a supervisory state. Zones are typically designed to enable someone to easily identify an area where the supervisory is located, for example, you may have all of the valve supervisory switches for one system on its own zone so the supervisory comes up as "supervisory wet pipe system 1."

Addressable supervisory devices are capable of communicating

a unique identification number or address to a control unit via a signaling line circuit. This identification consists of a binary string of 1s and 0s that indicate the address or location of that device on the circuit. When the FACU polls a supervisory device, the device responds with its status (normal, supervisory, etc.) and address. The device address allows for the location to be identified at the FACU. When one supervisory device is activated on a signaling line circuit, the FACU is still able to poll the other devices unlike a conventional initiating device circuit.

### Signaling Line Circuit

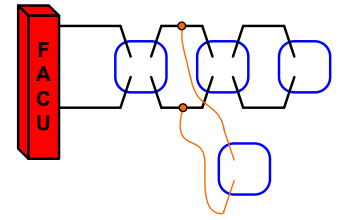

Additionally, some addressable supervisory devices are also able to transmit to the FACU a range of values such as temperature, water level, pressure, and other variables, and then the control unit software determines the set points for initiation of a supervisory signal. These types of supervisory devices are known as analog addressable as they are able to tell the FACU their address and their value.

Valves that can shut off the water supply for a fire suppression system such as a sprinkler system are required to be supervised to ensure that they are not closed while the system is in service. One way of supervising these valves is the use of the fire alarm system. This is done by installing a switch, which will send distinct signals to indicate that either a control valve has been moved from its normal position (typically meaning that the valve has been shut) or that the control valve has been restored back to its normal position.

### Valve Position

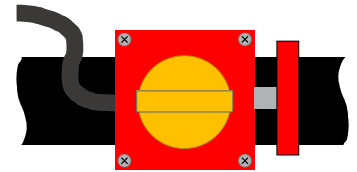

Water-based fire suppression systems are required to be maintained above a temperature of 40°F (4°C) where the system piping is filled with water. One way to ensure that these systems are not subject to freezing temperatures is to utilize the fire alarm system. This is done by placing temperature devices that can send a signal to the fire alarm control unit when the temperature in a space has dropped below 40°F (4°C) and for when the temperature has been restored to a temperature above 40°F (4°C).

### Room Temperature



If a building has a fire suppression system other than a sprinkler system such as a kitchen hood suppression system, or an inert gas system, it may be required to be monitored by the fire alarm system. Based on the system type and the building occupancy,

some of the signals may appear on the fire alarm control unit as a supervisory signal, which indicates that there is an issue with the suppression system that must be addressed. The other suppression systems may be connected directly to the building fire alarm control unit, or the other suppression system is controlled by its own fire alarm control unit (known as a releasing panel) that is then connected to the buildings main fire alarm control unit.

### Other Suppression Systems

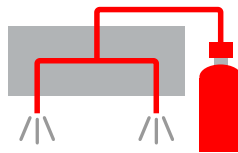

Some water-based fire suppression systems such as a dry pipe or preaction sprinkler system may require the use of pressurized air or nitrogen within the system piping. In some cases, the pressure within the piping is required to be supervised by the fire alarm system. This is done using pressure transducers or pressure switches that are connected to the fire alarm control unit. A supervisory condition may then be created if the pressure in the piping is too high, or too low.

If the building has a fire pump that supplies a water-based fire suppression system such as a sprinkler system or a standpipe system, the fire alarm control unit is connected to the fire pump controller to monitor for the following conditions:

### Fire Pump



- Pump or engine running
- Controller main switch off normal
- Trouble with the controller or engine
- Main power to electric fire pump disconnected
- Phase reversal on electric fire pump
- Loss of phase on electric fire pump

For more information on fire pumps take a look at this [blog](#).

If a water tank is used to supply a water-based fire suppression system, the water level in the tank and the temperature of the water may need to be monitored. This is done by installing water level sensors within the tank that can send a signal if the water level drops by a specified level, and the installation of water temperature sensors that can send signals if the temperature drops below 40°F (4°C) and for when the temperature has been restored to a temperature above 40°F (4°C).

### Water Tank

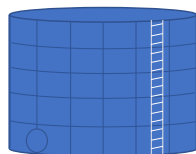

## PART 3 Power Supply

It is important for a fire alarm system to be provided with reliable power so it can operate during any emergency. There are a few different options when it comes to choosing a reliable power

supply, as well as some calculations that are necessary to ensure that the fire alarm system is provided with sufficient backup power.

There are a few different options out there when it comes to providing a reliable power source. They include providing an additional power source in addition to the primary power such as batteries or an emergency generator so there is backup power if primary power is lost or providing power through a single source such as a stored-energy emergency power supply system (SEPASS).

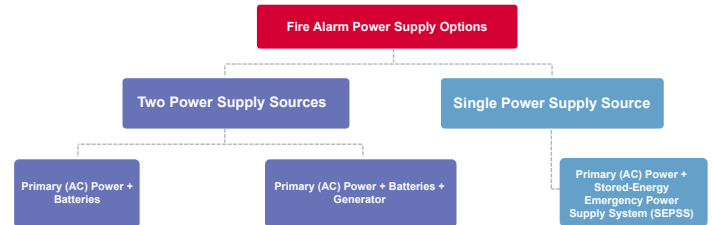

Primary power to the fire alarm system can be provided by the electric utility, an engine-driven generator (this is not a standby generator, however it is a site generator meeting the requirements in NFPA 72®, *National Fire Alarm and Signaling Code*®, and SEPASS, or a cogeneration system.

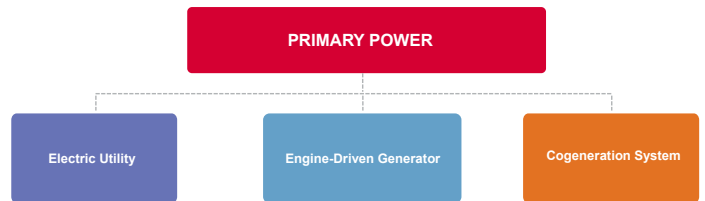

Batteries are a common way to provide a secondary power supply, the most common type of battery is a valve-regulated lead-acid battery and they are typically located within the fire alarm control unit enclosure, or in a separate battery box located near the fire alarm control unit. Batteries need to be sized so that they can provide power to the entire fire alarm system for 24 hours in standby and 5 minutes in alarm, if the system is an emergency voice alarm communication system (EVACS), then the batteries need to provide capacity for 15 minutes in alarm in addition to the 24 hours in standby. The additional time is required to allow for a longer evacuation time as buildings with an EVACS typically utilize a partial evacuation that would require constant communication with the occupants during the evacuation.

### Batteries

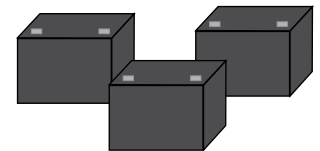

Another common way of providing a secondary power supply for a fire alarm system is the use of an emergency generator designed, installed, and maintained in accordance with NFPA 110, *Standard for Emergency and Standby Power Systems*, which



provides power to the fire alarm system through an automatic transfer switch. If using an emergency generator, you are still required to provide batteries as well just in case there is an issue with getting the emergency generator started. These batteries however, only need to provide a capacity for 4 hours instead of the 24 hours in standby.

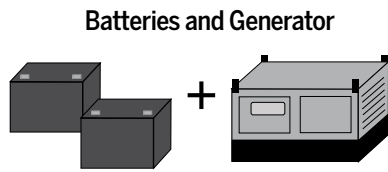

Instead of providing two separate power supplies, you are permitted to provide power via a SEPSS otherwise known as an energy storage system (ESS) or an uninterruptible power supply (UPS). The SEPSS must be configured in accordance with NFPA 111 and provide 24 hours of backup battery. The SEPSS is also fed via a compliant primary power supply such as utility power or an on site generator.

**Stored-Energy Emergency Power Supply System (SEPSS)**

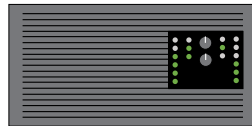

As noted below, if batteries are part of the secondary power source for a fire alarm system then they must be sized to provide capacity to run the system for 24 hours in standby and then either 5 minutes in alarm or 15 minutes in alarm for EVACS. A simple calculation for a basic fire alarm can be seen below.

**Battery Calculations**

Item	Standby Current (AMPS)	QTY	Total Standby Current (AMPS)	Alarm Current (AMPS)	QTY	Total Alarm Current (AMPS)
Fire Alarm Control Unit	0.1	1	0.1	0.2	1	0.2
Smoke Detector	0.001	4	0.004	0.05	4	0.2
Horn Strobe	0	10	0	0.075	10	0.75
<b>Total System Standby Current (AMPS)</b>			<b>0.104</b>	<b>Total System Alarm Current (AMPS)</b>		<b>1.15</b>

1	Required Standby Time (HRS)	X	Total System Standby Current (AMPS)	=	Required Standby Capacity (AMP-HRS)
	24	X	0.104	=	2.496

2	Required Alarm Time (HRS)	X	Total System Alarm Current (AMPS)	=	Required Alarm Capacity (AMP-HRS)
	0.083 (5 mins)	X	1.15	=	0.095

  

3	Required Standby Capacity (AMP-HRS)	+	Required Alarm Capacity (AMP-HRS)	=	Total Capacity (AMP-HRS)	X	Safety Factor (25%)	=	Required Battery Capacity (AMP-HRS)
	2.496	+	0.095	=	2.59	X	1.25	=	3.24

1. First the total system standby current and the total system alarm current is calculated. This is done by multiplying the standby current and alarm current for each piece of equipment by the total quantity of each piece of equipment and adding them together, the result is the total amps required in standby and alarm. Both the standby current and the alarm current for equipment can be found from the manufacturer in the data sheet.
2. Next total standby capacity is required by multiplying the total system standby current by the required 24 hours to achieve the required standby capacity in amp-hrs. The same is done with the alarm capacity, however, instead of 24 hours, the current is multiplied by either 5 minutes (0.083 hours) or 15 minutes (.25 hours) to achieve the required alarm capacity in amp-hrs.
3. Finally, both the standby capacity and the alarm capacity is added together and a 25% safety factor is applied to arrive at the total required battery capacity.

**PART 4 Notification**

A fire alarm system can notify the occupants and in some cases on site emergency forces of an emergency. Notification is provided via visible and audible notification appliances. The visible notification is typically provided via strobes, and audible notification is provided by either speakers, which can provide different tones and voice signals, or horns, which can only provide a single sound. The fire alarm control unit provides the signal to the notification appliances via a notification appliance circuit (NAC). When a fire alarm system is installed within a building, the requirements for the type of notification (audible, visible, and voice) is driven by the building code, fire code, or life safety code that is adopted in that jurisdiction.

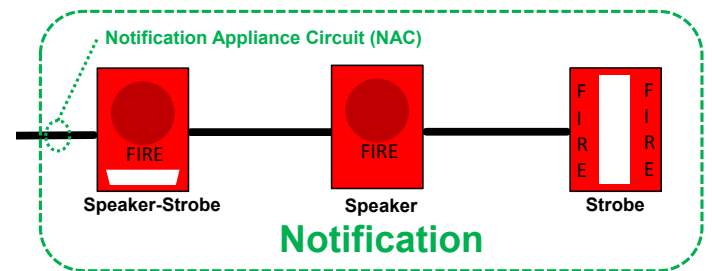

Notification appliances are controlled by the fire alarm control unit (FACU) using a notification appliance circuit (NAC). Each notification appliance has a diode in it that only allows current to pass through it in one direction (think of it like a one way valve). In a non-alarm condition, the FACU will send a small supervisory voltage through the circuit to monitor it for integrity (typically 6 vdc). The supervisory voltage is sent through in a direction such that the diodes do not allow any current to pass through the notification appliances. If the FACU no longer sees the supervisory voltage, it knows that there is an issue and it will

create a trouble condition. During an alarm condition the FACU will reverse the polarity of the voltage (switch the direction of the current flow) and increase it (typically to 24 vdc). Since the direction of the flow has changed, the diodes will allow the current to flow through the notification appliances and cause the audible and or visual notification.

### Notification Appliance Circuit

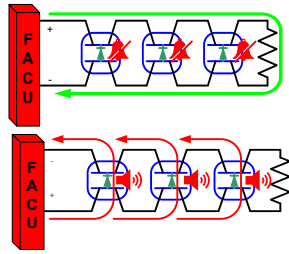

The audible notification can consist of either tones and a voice message, or just tones. Fire alarm speakers are used to create tones and voice messages, while a horn can only create a tone or single sound. Notification appliances can just be speakers or horns, or they can be a combination unit which provides a strobe light in addition to the speaker or horn. You may see these appliances mounted on the wall or on the ceiling.

### Audible Notification

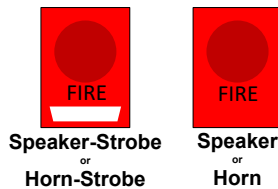

The audible notification is designed to produce a specific sound pressure level (volume). This sound pressure level is measured in decibels. The design is based on producing a sound level that is over the ambient sound level of the space. The required sound level is based upon the type of signaling mode the system is using, it can be either public mode signaling, or private mode signaling. There is not a requirement for the specific sound that is used, however, there is a requirement for the sound pattern, and in some cases, there is a requirement for the frequency (pitch) of the sound.

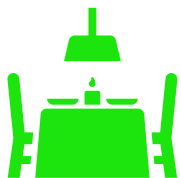

### Public Vs Private Mode



Public mode signaling is used when you want to alert all the occupants within the building that there is an emergency, while private mode signaling is used to only alert the occupants responsible for responding that there is an emergency. For example, a fire alarm system within a restaurant would utilize public mode signaling to alert all the occupants that there is an emergency and that they need to evacuate. On the other hand, in a hospital the fire alarm system may utilize private mode signaling to alert the hospital staff that there is an emergency, and they need to begin evacuating or relocating the patients in accordance with their emergency action plan. For more information on private

operating mode, take a look at this [blog](#).

Public mode signaling is required to have a sound level that is at least 15 decibels above the average ambient sound level and 5 decibels above the maximum sound level having a duration of 60 seconds, while private mode signaling is only required to have a sound level that is at least 10 decibels above the average ambient sound level and 5 decibels above the maximum sound level having a duration of 60 seconds. In addition to public and private operating mode, there are some requirements that are specific to areas in which occupants may be sleeping.

While these operating modes address how a system must be designed in regard to the sound level, it is important to note that some buildings may utilize different zoned notification strategies. For example, a high-rise building may implement a notification strategy where they notify the occupants on the fire floor along with the occupants on the floor above and the floor below. After those floors are evacuated, other floors can be notified to evacuate.

### Temporal 3 – Evacuation / Relocation

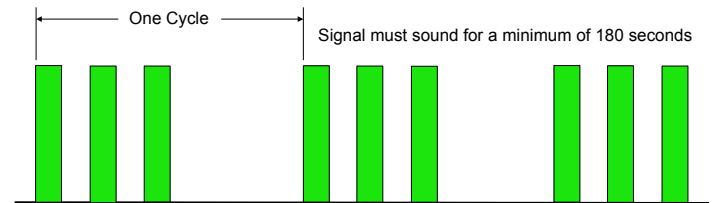

If the fire alarm system is notifying the occupants that they need to evacuate or relocate, the system must utilize the temporal 3 pattern. There is no requirement for the sound that is used to create the pattern, it can be a horn, bell, chime, or even a slow whoop. In the case of sleeping areas, the sound is required to have a low frequency 520 Hz (typical fire alarm notification frequencies are in the 3150 Hz range) as studies have shown that this low frequency is more effective at waking occupants. For fire alarm systems utilizing a voice message, the voice message will proceed the temporal 3 signal. For an example of a temporal 3 signal take a look at this [video](#).

### Temporal 4 – Carbon Monoxide

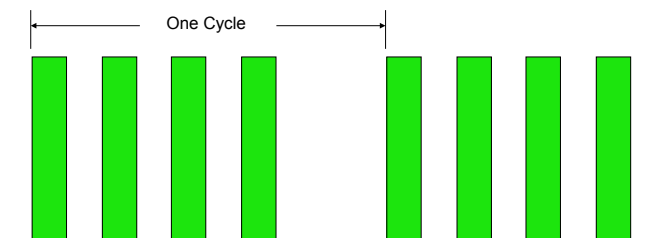

Where the occupants are required to be notified of carbon monoxide within a building, a temporal 4 pattern is to be used. For an example of the temporal 4 take a look at this [video](#).

## Visual Notification

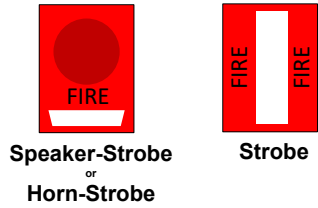

Types of visual signaling from a fire alarm system include strobe lights, textual signals, and graphical signals. The most common type of visual signals provided to occupants from a fire alarm system is the use of strobes. The notification appliances that create these visual signals can be just a strobe or can be a combination speaker-strobe or horn-strobe. You may see these appliances mounted on either the wall or the ceiling.

The systems are designed to produce a given amount of light over the area in which notification is required, this light level is measured in lumens/ft<sup>2</sup> or lumens/m<sup>2</sup>. Based on the type of notification being provided (private mode or public mode) strobes may be placed to provide notification to all the occupants, or only the occupants responsible for responding.

A control circuit is essentially a notification appliance circuit (NAC) that is used to send power to a relay instead of notification appliances. A relay is a switch that is open and closed electromechanically and allows the fire alarm control unit to operate emergency control functions. As seen above, power sent from the fire alarm control unit will energize an electro-magnet coil, which will cause the switch, which is controlling power coming into the common terminal (C) to move from the normally closed (NC) position to the normally open (NO) position. This switch can then be used to control other systems.

## Output Module

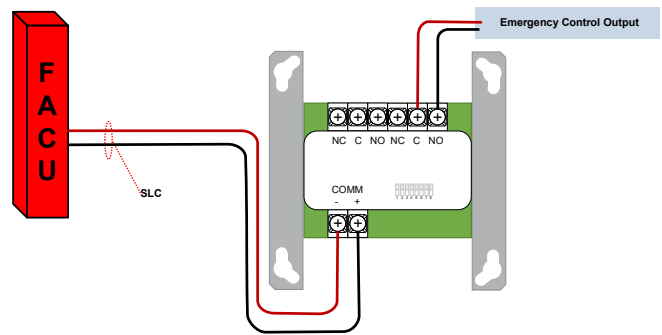

The control outputs from a fire alarm control unit can also be sent out on a signaling line circuit (SLC) to an addressable output module, which can open or close a contact based on information sent from the fire alarm control unit on the SLC to the COMM terminals. This is beneficial because multiple output modules can be controlled by the same SLC, which can control each module separately. For example, all output modules controlling all of the door hold opens in a building could be on the same SLC, but based on the specific input to the control unit, only specific doors can be closed. If all of these modules were on the same control circuit, the control unit would only be able to close all the doors.

The fire alarm control unit can also be used to send a signal to the elevator controller to initiate elevator recall or shutdown. The fire alarm control unit will send a signal to send the elevator to the designated level (typically street level) when a smoke detector on any floor lobby or in the elevator machine room detects smoke, if smoke is detected in the designated level lobby the elevator will be sent to the alternate level (typically the level above the designated level). This is done to protect any of the occupants in the elevator by ensuring that they exit the building and do not go to a floor that has a fire on it.

If the elevator hoist way, pit, or machine room is required to have sprinklers, the fire alarm control unit is used to cut power to the elevator via a shunt trip prior to sprinkler activation to protect occupants. This is done by either placing a heat detector with a lower response time index (RTI) next to the sprinkler or by using a waterflow switch next to the sprinkler. The lower RTI means the heat detector would activate before the sprinkler, if a waterflow switch is used, it would need to have a 0 second time delay.

## PART 5 Emergency Control Functions

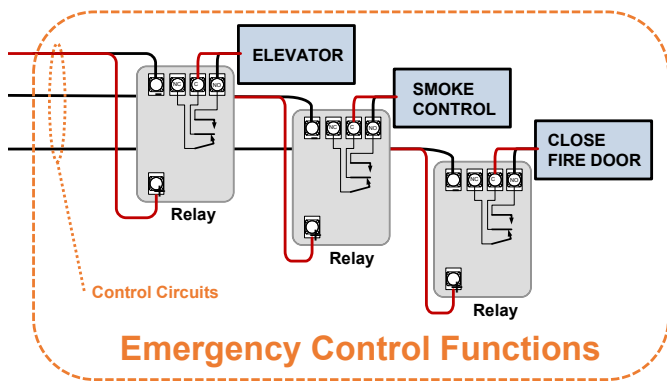

The fire alarm control unit can be used to control the function of other systems such as elevator recall, automatic door closers, smoke control systems, and so on. The most common way that the fire alarm can do this is through the use of a control circuit and a relay.

## Relay

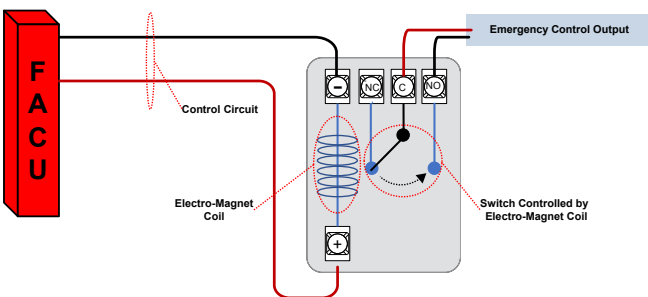



## Elevator Recall / Shutdown

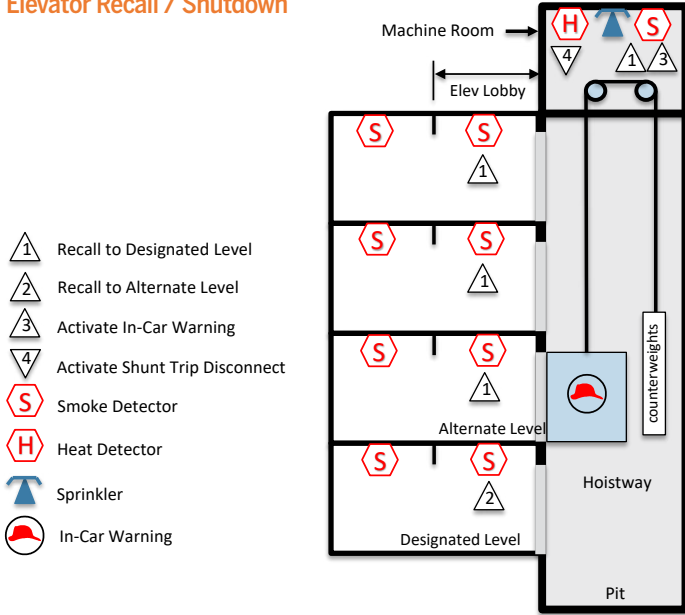

Many building designs include the use of large open spaces such as atriums that connect multiple floors of a building. To keep occupants safe in the event of a fire, a smoke control system may be needed to maintain the level of smoke above the occupants as they are exiting the building. These systems may be composed of exhaust fans and makeup air openings that are all controlled by a separate smoke control panel. The fire alarm control unit is responsible for sending a signal to the smoke control panel to initiate smoke removal when specific smoke detectors, pull stations, and waterflow alarms within the protected space are actuated. Additionally, the fire alarm control unit may be responsible for closing specific fire doors and dampers to enclose the smoke control zone. Want to learn more about smoke control systems? Check out this [blog](#).

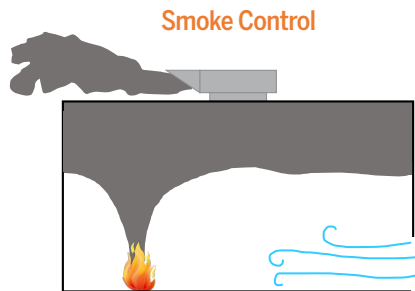

If a fire were to start within a building, an important objective is to contain the fire and products of combustion within an enclosed space for as long as possible. This is accomplished through construction that can resist the passage of fire. In most buildings these fire-resistant barriers can be found in corridor walls, and shafts (including stairwells). Openings within the fire-resistant construction need to be protected with fire doors. For these doors to be effective they need to be closed, so they are equipped with automatic closers. In some cases, the fire alarm can be used to hold these doors open with an electro-magnet door holder. Upon alarm, the fire alarm control unit will send a signal to cut power to the electro-magnets allowing the door to close.

## Automatic Door Closer

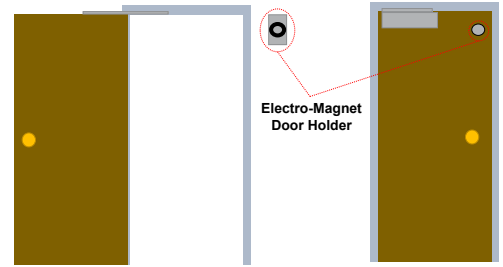

A key piece of documentation for the fire alarm system is known as the input/output matrix. This table outlines all the outputs from the fire alarm control unit when a given input is received. Above is a portion of the input/output matrix outlining elevator recall. An example shown on this chart would be when the fire alarm control unit receives an input from the 1st floor elevator lobby smoke detector (row 6) it will activate the NAC circuit 1 and NAC circuit 2 as well as send a signal to the elevator controller to recall the elevator to the alternate level. This document is key to the proper design of a fire alarm system and is also a crucial when performing testing to ensure that all of these systems are working as intended.

## Input Output Matrix

	Input	System Outputs				
		NAC Ckt 1	NAC Ckt 2	Elev. Recall to Designated Level	Elev. Recall to Alternate Level	Machine or Control Space
1	Basement	●	●			
2	1st	●	●			
3	2nd	●	●			
4	3rd	●	●			
5	Basement Elev. Lobby SD	●	●		●	
6	1st Elev. Lobby SD	●	●		●	
7	2nd Elev. Lobby SD	●	●	●		
8	3rd Elev. Lobby SD	●	●	●		
9	Elevator Pent. SD	●	●	●		●
10	Elev. Hoist. SD (if used)	●	●	●		●
11	Atrium Beam Det.	●	●			

When a fire alarm control unit controls another system, it is known as system integration. It is crucial that the fire alarm system along with all integrated systems are tested properly. For more information on integrated fire protection and life safety system testing take a look at this [fact sheet](#) on NFPA 4. [Go here](#) for an interactive learning module on integrated system testing.

## PART 6 Off-Premises Signaling and Supervising Stations

When talking about fire alarm systems, the term premises includes the entire area monitored by the fire alarm, this could include the entire building or even an entire campus. Off premises signaling is important because it allows signals from the fire alarm system to be sent to a constantly attended location (supervising station or a public communication center) to ensure the proper response.

The purpose of off-premises signaling is to provide dedicated, 24-hour monitoring for a fire alarm and signaling system and to initiate the appropriate response to those signals. In the case of a fire alarm condition (fire detected in the building), the appropriate response usually includes the dispatching of the local fire department or fire brigade. In the case of a supervisory condition, such as a closed sprinkler valve, the appropriate response might be the notification of designated maintenance personnel or outside contractors.

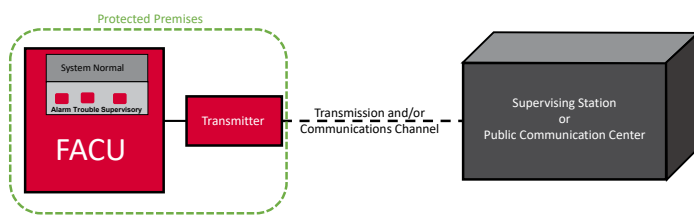

If a fire alarm and signaling system is sending signals off premises, it is either (1) sending signals through a public emergency alarm reporting system, or (2) the fire alarm system is part of a supervising station alarm system. Regardless of the system, in today's world they all consist of a type of transmitter at the protected premises that uses a transmission and/or communications channel and pathway to send signals to a receiver at the supervising station or public communications center.

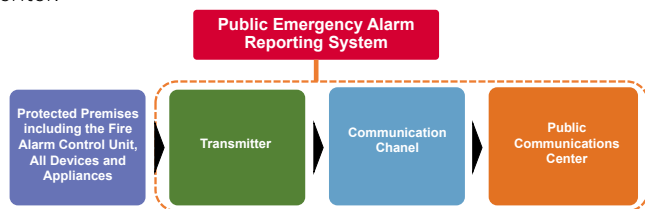

A public emergency alarm reporting system (PEARS), otherwise known as a municipal emergency (fire) alarm system is a communication infrastructure, other than a public telephone network that is used to communicate with a communication center. Typically, this communication infrastructure is owned, operated, and controlled by a public agency. The system itself does not include the fire alarm control unit or any of the equipment that is located on the protected premise, instead, it starts at the transmitter and ends at the public communication center.

One way the interface between the fire alarm control unit and the PEARS is completed is using a master fire alarm box, which is an addressable manual pull station on the PEARS system that has an interface circuit that allows a fire alarm control unit to actuate the master box when the system initiates a fire alarm signal.



Large municipalities usually locate the communications center at a facility designed for the purpose. Small communities often locate the communications center at the fire station, police station, sheriff's office, or a private agency that has been contracted to provide public emergency communications services. NFPA 1221, *Standard for the Installation, Maintenance, and Use of Emergency Services Communications Systems*, provides requirements for the installation, performance, operation, and maintenance of communications systems and facilities.

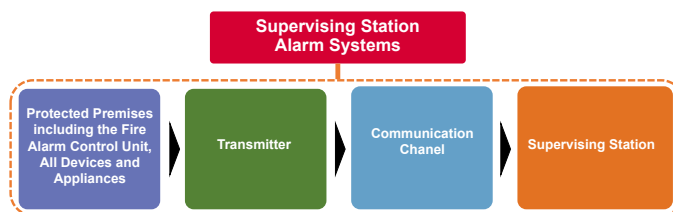

If off-premises signaling is provided by a private company, it is most likely completed using a supervising station alarm system. A supervising station alarm system consists of everything connected to the supervising station, including the protected premises fire alarm control unit and devices.

Supervising station alarm systems are further divided into three specific types. They are:

1. Central Station Service Alarm Systems
2. Proprietary Supervising Station Alarm Systems
3. Remote Supervising Station Alarm Systems

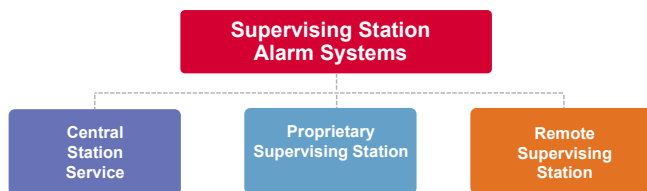

A central station service alarm system consists of a remotely located supervising station that is listed for central station service to UL 827, *Standard for Central-Station Alarm Services*, in addition to monitoring, it provides several other services including record keeping and reporting, testing services, and runner service. This can either be required by code or some insurance companies for certain occupancies. This option can also be chosen by a building owner who wants to have a single contract with a provider who supplies monitoring as well as inspection, testing, and maintenance and other services required of central stations.

A proprietary supervising station alarm system consists of a supervising station under the same ownership as the protected building that it supervises. These can be useful to owners who have very large buildings or a campus or for owners who have numerous buildings in many locations and who are able to dedicate the space and staffing levels to accomplish this. Proprietary supervising stations can be located on the same premises as the fire alarm system or at another location; these are most often used by large airports, industrial plants, college campuses, large hospitals, and retail chains, among other facilities. An example of this is a big box store that has a dedicated location that monitors all of its store locations. Additional fire alarm services including record keeping, equipment installation, inspection, testing, and maintenance are the responsibility of the owner and can be accomplished in-house or be contracted out to an outside contractor.

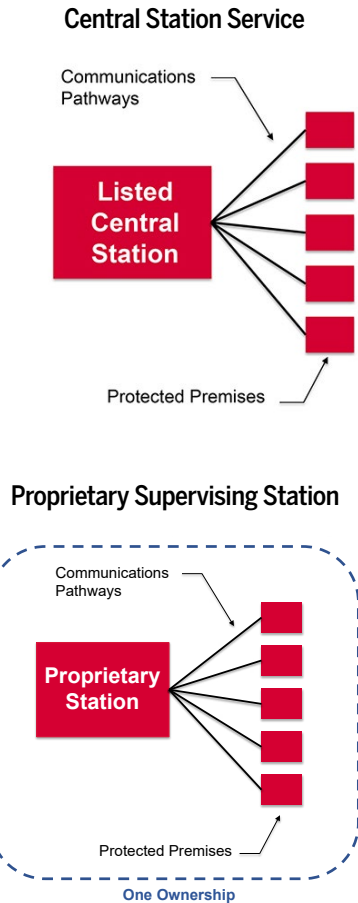

A remote supervising station alarm systems consists of a constantly attended location that receives signals from various

#### NFPA References Cited

- NFPA 4, *Standard for Integrated Fire Protection and Life Safety System Testing*, 2021 edition
- NFPA 72®, *National Fire Alarm and Signaling Code*®, 2022 edition
- NFPA 110, *Standard for Emergency and Standby Power Systems*, 2022 edition
- NFPA 111, *Standard on Stored Electrical Energy Emergency and Standby Power Systems*, 2022 edition
- NFPA 1221, *Standard for the Installation, Maintenance, and Use of Emergency Services Communications Systems*, 2019 edition

protected premises typically owned by different parties. Unlike central station fire alarm systems, contracts for this service are typically limited to the monitoring and recording of signals from the fire alarm system. Additional services including equipment installation, inspection, testing, and maintenance are the responsibility of the owner. This is an option for owners who are not required or do not want to provide central service and for whom a proprietary supervising station does not make sense. It also may be common for a municipality to operate a remote supervising station as a way to receive signals at their communication center if they are not utilizing a public emergency alarm reporting system.

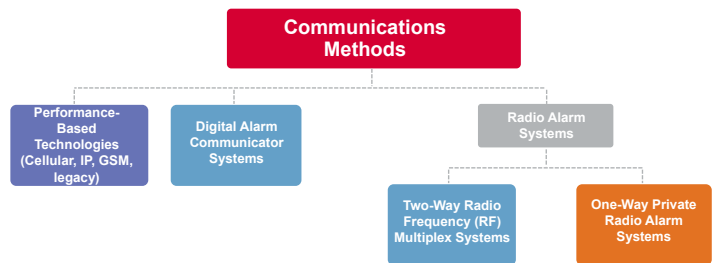
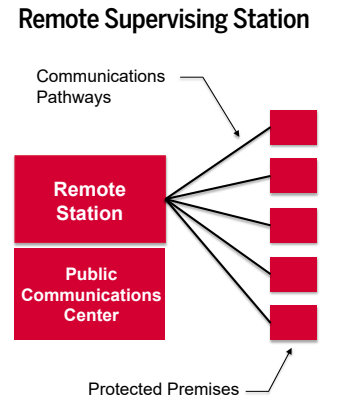

There are many different methods that can be used for the fire alarm control unit to communicate to the supervising station, and NFPA 72 outlines the requirements for four different types that are permitted in new installations, which includes both wired and wireless methods.

**Learn More**

- ▶ Visit [nfpa.org/FPSSolutions](https://nfpa.org/FPSSolutions) for the latest fire protection systems resources from NFPA, including research, featured products, training options, and certification opportunities.